



=25°C (unless otherwise specified)

=25°C
=100°C

±

=25°C
=25°C

°C

°C/W

°C/W



=25°C (unless otherwise specified)

=±20V, V

=25°C

=100°C

±



--	--

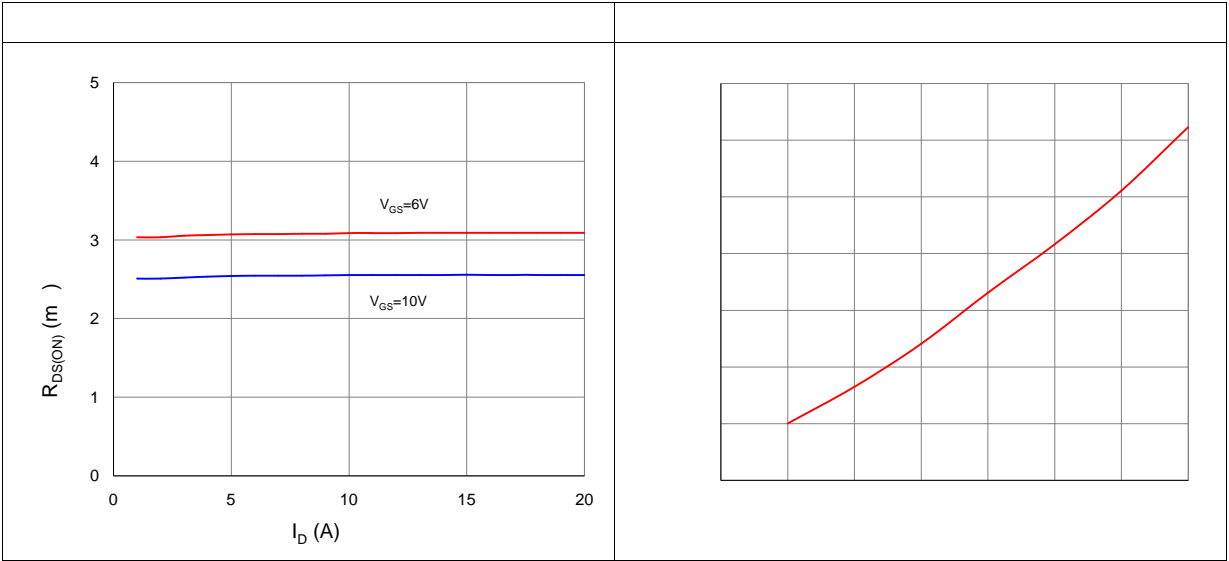

--	--

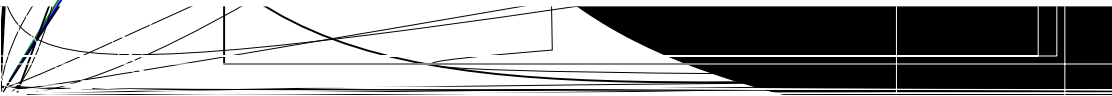
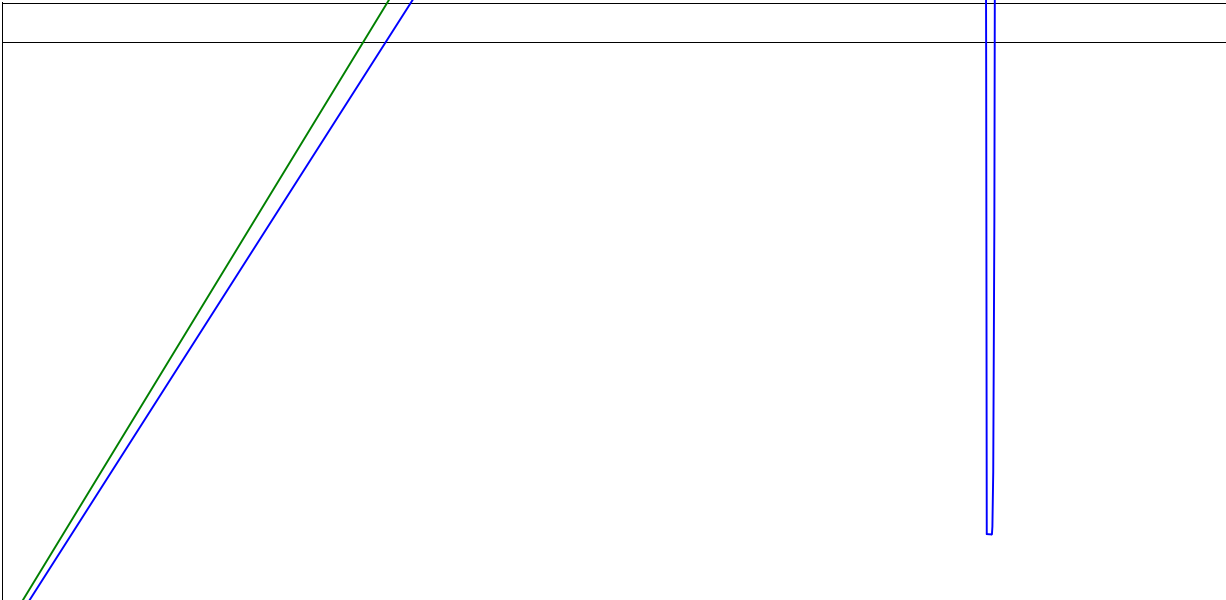
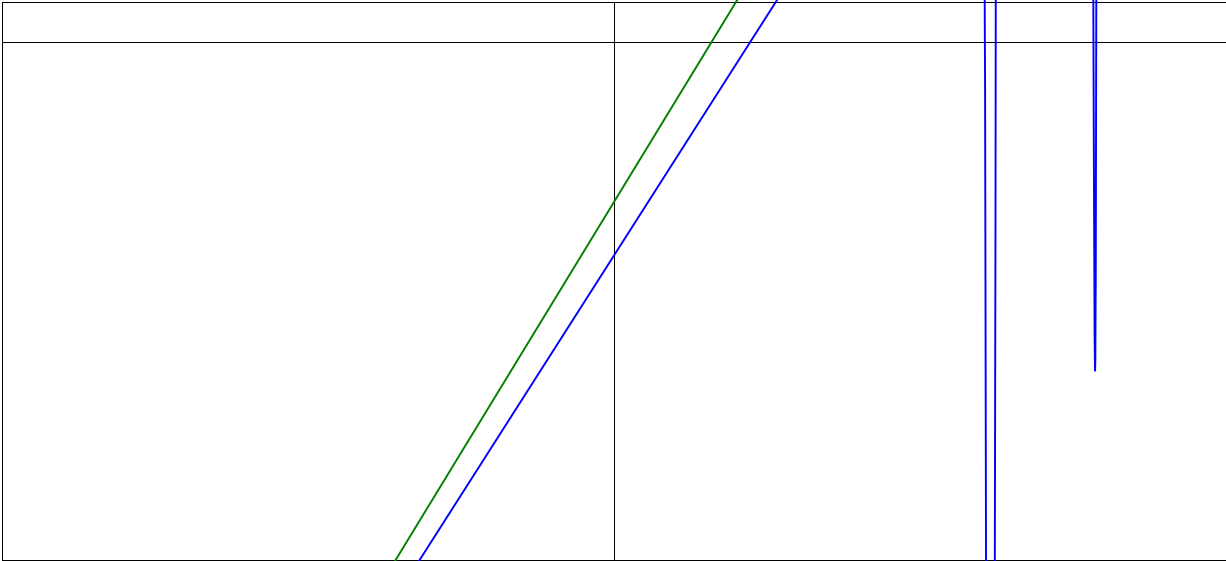
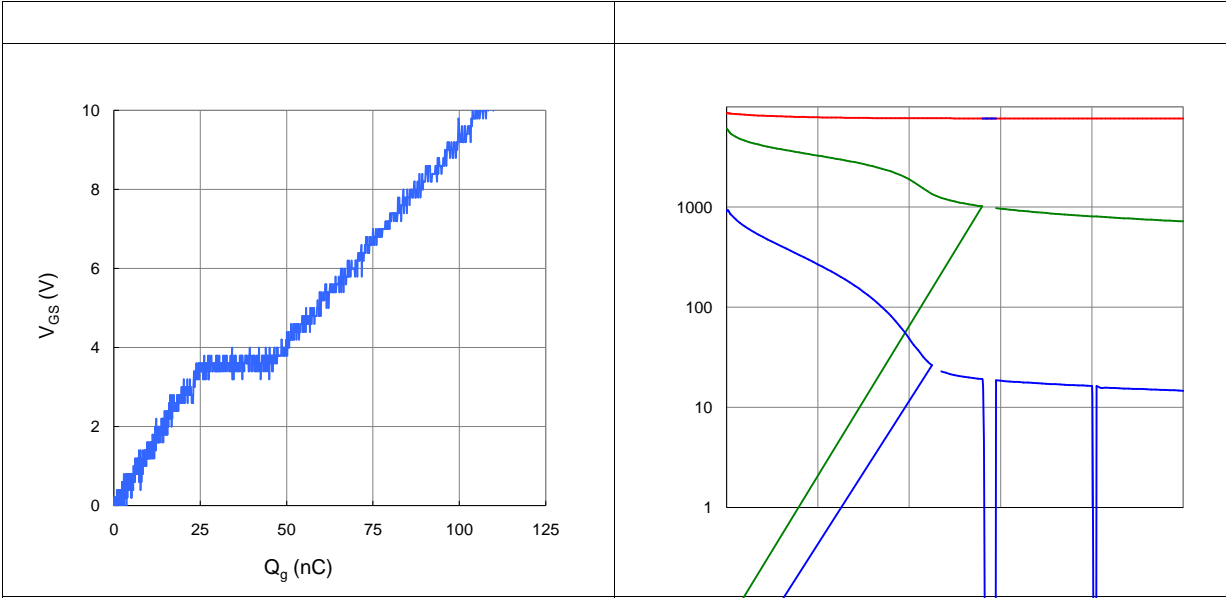

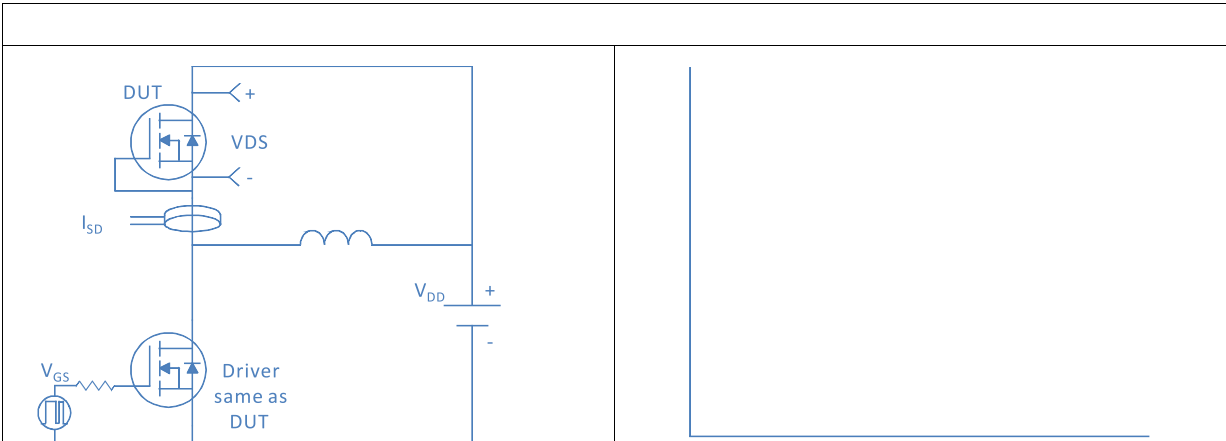
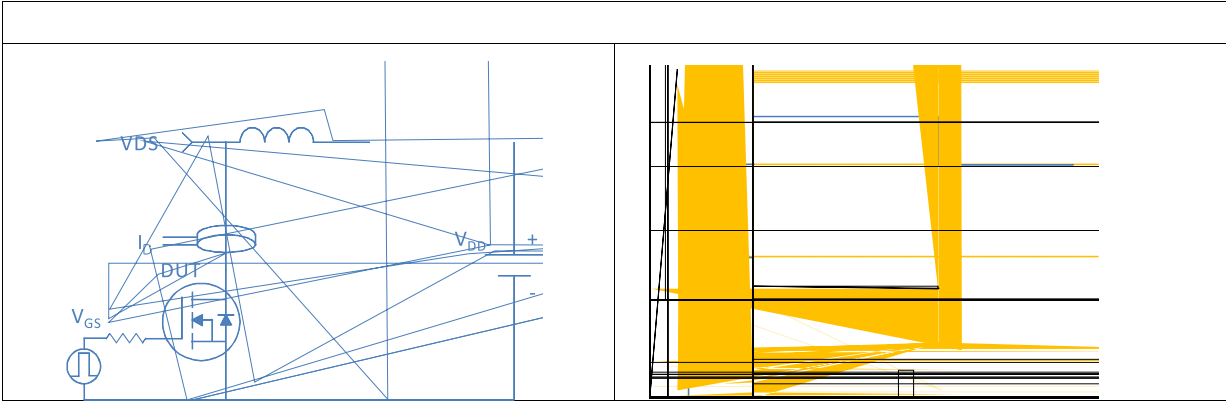
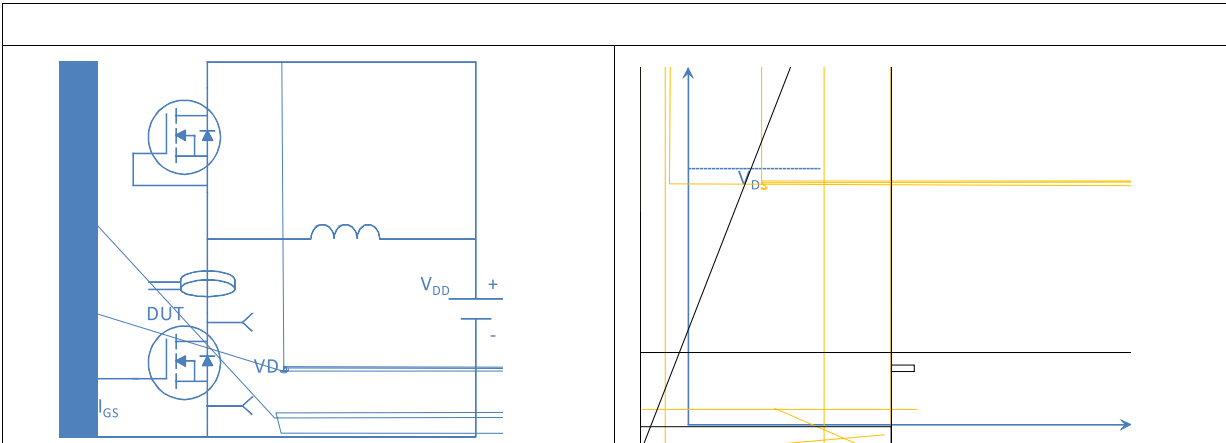
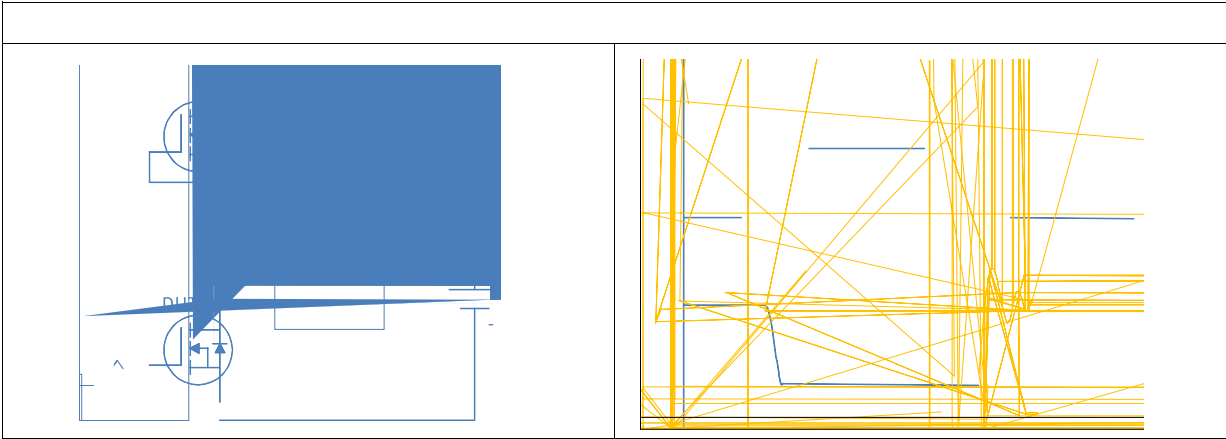

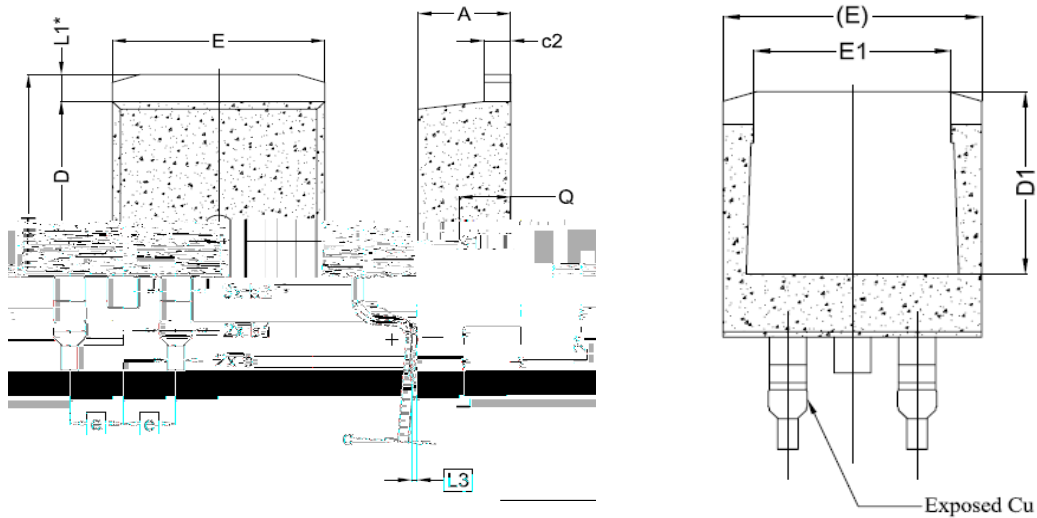

SYMBOL	DIMENSIONS		
	MIN.	NOM.	MAX.
A	4.24	4.44	4.64
A1	0.00	0.10	0.25
b	0.70	0.80	0.90
b1	1.20	1.55	1.75
b2	1.20	1.45	1.70
c	0.40	0.50	0.60
c2	1.15	1.27	1.40
D	8.82	8.92	9.02
D1	6.86	7.65	—
E	8.82	10.12	10.52
E1	8.12	9.77	9.92
e	2.64 BSC		
H	14.61	15.30	15.88
L	1.78	2.32	2.79
L1	1.35 REF.		
L2	1.50 REF.		
L3	0.25 BSC		
Q	2.30	2.48	2.70

